

Technical Specification

Adjustable-Length Curved Shower Rod

CSR2168

Stock Numbers:

- **CSR2168CH - Adjustable-Length Curved Shower Rod**
Chrome Finish
Adjusts to fit shower enclosures between 34-inches to 60-inches
- **CSR2168BN - Adjustable-Length Curved Shower Rod**
Brushed Nickel Finish
Adjusts to fit shower enclosures between 34-inches to 60-inches
- **CSR2168BL - Adjustable-Length Curved Shower Rod**
Matte Black Finish
Adjusts to fit shower enclosures between 34-inches to 60-inches

Dimensions:

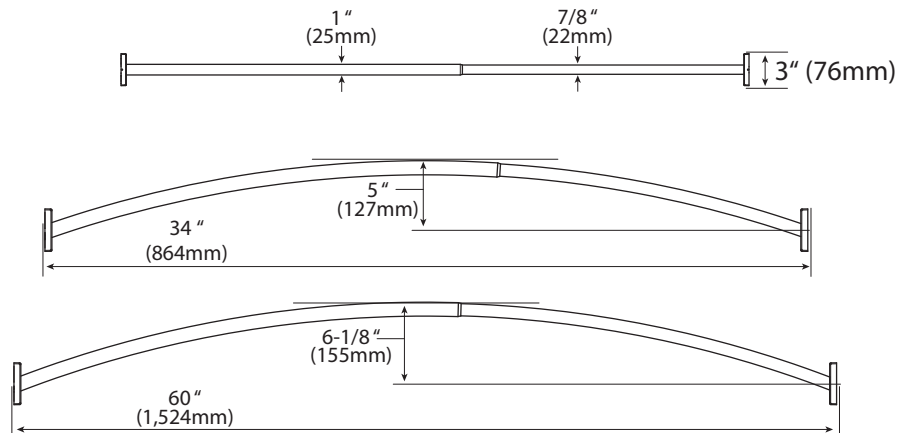

Materials:

Curved Shower Rods are made of .028 (22 gauge) seamless type 430 stainless steel. **Decorative Covers** are stamped from .020 type 304 stainless steel.

Pivoting Mounting Post is made from POM. The **screw** in the pivoting post assembly is made from stainless steel.

Rod connector is made from polyethylene.

Stock Number: _____ CSR2168
Adjustable-Length Curved Shower Rod

MOEN®

25300 AL MOEN DRIVE • NORTH OLMSTED, OH 44070
CONSUMER SUPPORT: (800) 289-6636 • FAX: (800) 848-6636
INTERNATIONAL: (440) 962-2000 • FAX: (440) 962-2726
CUSTOMER SERVICE (USA): 800-882-0116 • FAX: (888) 379-2720
WWW.MOEN.COM
© 2023 Moen Incorporated.